



Micro Commercial Components

Micro Commercial Components
 20736 Marilla Street Chatsworth
 CA 91311
 Phone: (818) 701-4933
 Fax: (818) 701-4939

Features

- Case Material: Molded Plastic. UL Flammability Classification Rating 94V-0 and MSL Rating 1
- Ideally Suited for Automatic Insertion
- 150°C Junction Temperature
- For Switching and AF Amplifier Applications
- Epitaxial Planar Die Construction

Mechanical Data

- Case: SOT-23, Molded Plastic
- Terminals: Solderable per MIL-STD-202, Method 208
- Polarity: See Diagram
- Weight: 0.008 grams (approx.)
- Marking: BC817-16 6A
 BC817-25 6B
 BC817-40 6C

Maximum Ratings @ 25°C Unless Otherwise Specified

Charateristic	Symbol	Value	Unit
Collector-Emitter Voltage	V_{CEO}	45	V
Emitter-Base Voltage	V_{EBO}	5	V
Collector Current	I_C	800	mA
Peak Collector Current	I_{CM}	1000	mA
Peak Emitter Current	I_{EM}	1000	mA
Power Dissipation@ $T_s=50^\circ\text{C}$ (Note1)	P_d	310	mW
Operating & Storage Temperature	T_j, T_{STG}	-55~150	°C

Note: 1. Device mounted on Ceramic Substrate 0.7mm X 2.5cm² area

BC817-16 THRU BC817-40

NPN Small Signal Transistor 310mW

SOT-23

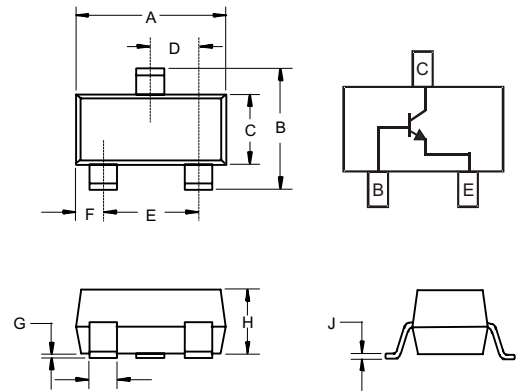

DIM	INCHES		MM		NOTE
	MIN	MAX	MIN	MAX	
A	.110	.120	2.80	3.04	
B	.083	.098	2.10	2.64	
C	.047	.055	1.20	1.40	
D	.035	.041	.89	1.03	
E	.070	.081	1.78	2.05	
F	.018	.024	.45	.60	
G	.0005	.0039	.013	.100	
H	.035	.044	.89	1.12	
J	.003	.007	.085	.180	
K	.015	.020	.37	.51	

Suggested Solder Pad Layout

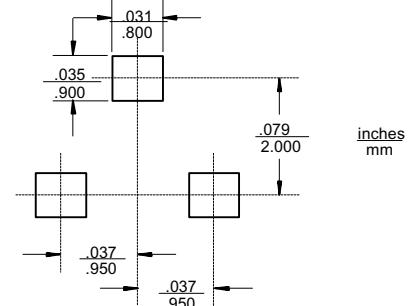

Electrical Characteristics @25°C unless otherwise specified

Characteristic	Symbol	Min	Max	Unit	Test Condition
DC Current Gain	Current Gain Group -16 -25 -40	100	250	—	$V_{CE} = 1.0V, I_C = 100mA$
		160	400		$V_{CE} = 1.0V, I_C = 300mA$
	Current Gain Group -16 -25 -40	250	600	—	
		60	—		
		100	—		
		170	—		
Thermal Resistance, Junction to Substrate Backside	$R_{\theta SB}$	—	320	K/W	
Thermal Resistance, Junction to Ambient Air	$R_{\theta JA}$	—	400	K/W	
Collector-Emitter Saturation Voltage	$V_{CE(SAT)}$	—	0.7	V	$I_C = 500mA, I_B = 50mA$
Base-Emitter Voltage	V_{BE}	—	1.2	V	$V_{CE} = 1.0V, I_C = 300mA$
Collector-Emitter Cutoff Current	I_{CES}	—	100	nA	$V_{CE} = 45V$
		—	5.0	μA	$V_{CE} = 25V, T_J = 150^\circ C$
Emitter-Base Cutoff Current	I_{EBO}	—	100	nA	$V_{EB} = 4.0V$
Gain Bandwidth Product	f_T	100	—	MHz	$V_{CE} = 5.0V, I_C = 10mA, f = 50MHz$
Collector-Base Capacitance	C_{CBO}	—	12	pF	$V_{CB} = 10V, f = 1.0MHz$

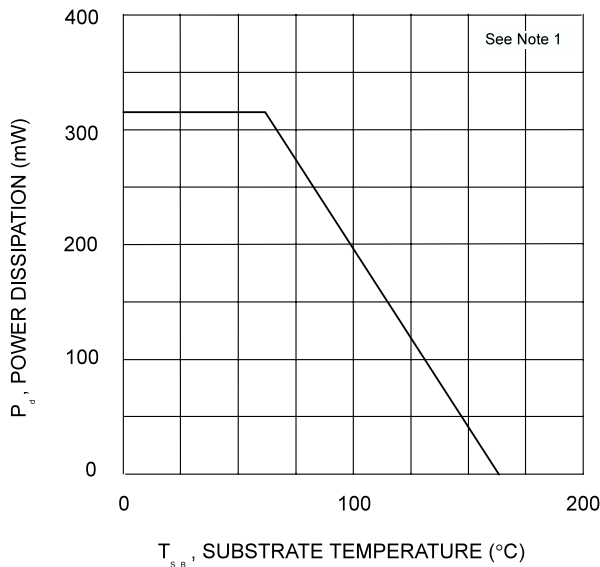

Fig. 1, Power Derating Curve

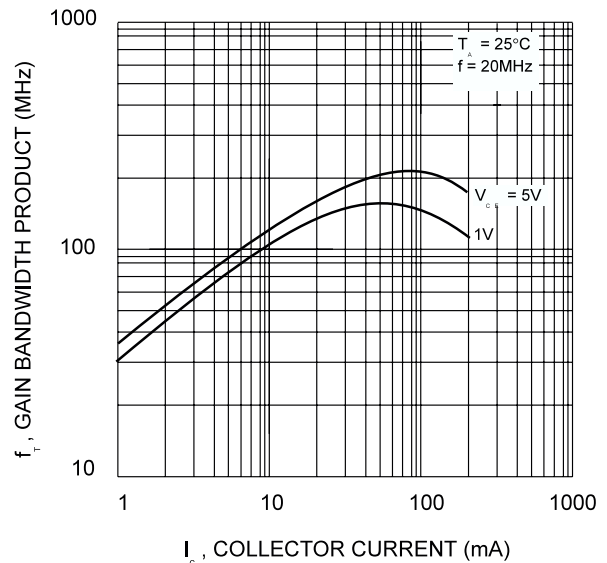

Fig. 2, Gain-Bandwidth Product vs. Collector Current

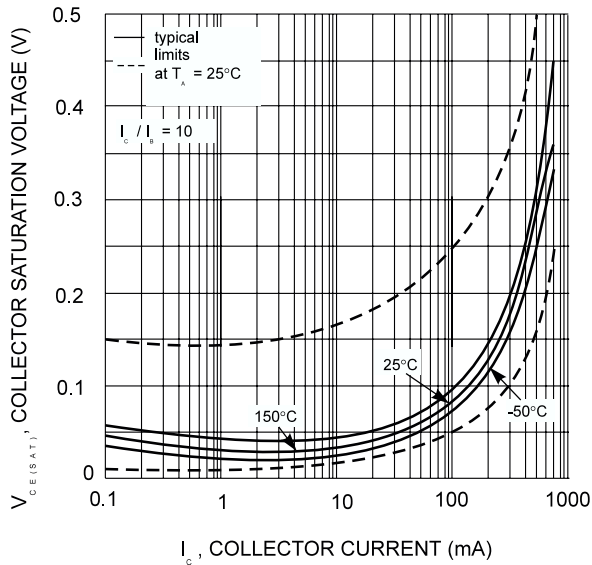

Fig. 3, Collector Sat. Voltage vs Collector Current

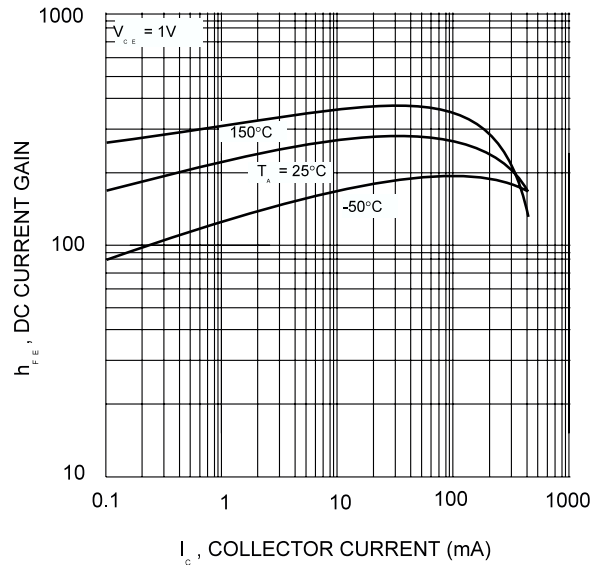

Fig. 4, DC Current Gain vs Collector Current

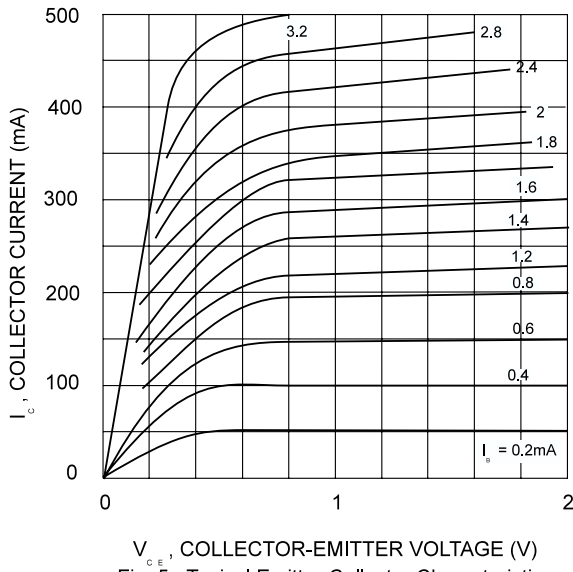

Fig. 5, Typical Emitter-Collector Characteristics

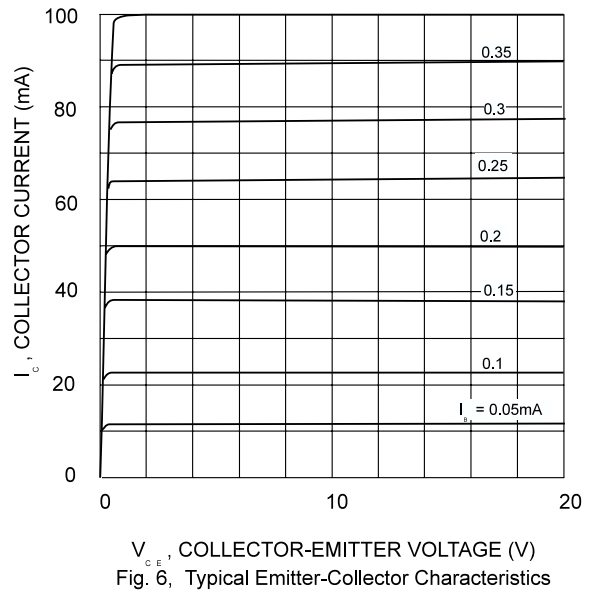

Fig. 6, Typical Emitter-Collector Characteristics



TM

Micro Commercial Components

Ordering Information

Device	Packing
(Part Number)-TP	Tape&Reel;3Kpcs/Reel

IMPORTANT NOTICE

Micro Commercial Components Corp. reserves the right to make changes without further notice to any product herein to make corrections, modifications, enhancements, improvements, or other changes. *Micro Commercial Components Corp.* does not assume any liability arising out of the application or use of any product described herein; neither does it convey any license under its patent rights, nor the rights of others. The user of products in such applications shall assume all risks of such use and will agree to hold *Micro Commercial Components Corp.* and all the companies whose products are represented on our website, harmless against all damages.

APPLICATIONS DISCLAIMER

Products offer by *Micro Commercial Components Corp.* are not intended for use in Medical, Aerospace or Military Applications.